

Great Separation and Clarification Solutions

Depth-Stack Filters

High Quality, High Efficiency, High Reliability

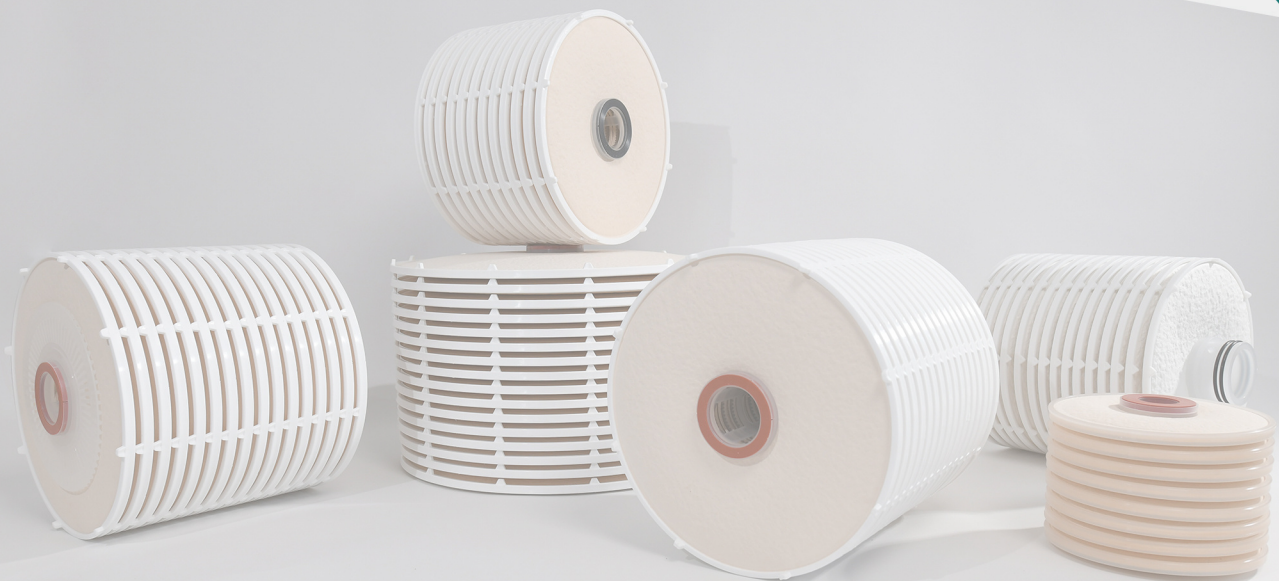



Great Wall Depth-Stack Filter Cartridges are available in multi-material filter sheets, which are widely used in pharmaceutical and food & beverage industries. The filter sheets are made from cellulose fibers and inorganic filter aids (Diatomaceous earth etc., it has three functions of surface filtration, depth filtration and electrostatic adsorption.

BDS series adopt domestic filter sheets, which shows excellent high throughput and cost-effective performance. Generally, larger particles in feed liquids are mechanically intercepted through three-dimensional and porous structure, while smaller particles and microorganisms are intercepted by positively charged electrostatic adsorption.

PDS series adopt imported filter sheets, which has excellent features as like low density, high porosity, large particle removal capacity and long service life etc. The product is mainly suitable for filtration of viscous materials, colloid particles or coarse dispersed materials with low differential pressure.

KKS series adopt domestic filter sheets, the unique buckling connection allows for stack-to-stack usage and it is easy to be installed and dismantled.

Guarantees

- Manufactured in a clean room environment
- Manufactured according to ISO9001:2015 certified quality management system
- All components materials meet the requirements of the EU framework regulation [1935/2004/EC] regarding materials and articles intended to contact food.
- All components materials meet the FDA Indirect Food Additive requirements cited in 21 CFR 177-182.

Dimension

Cells	8 cells / 9 cells / 12 cells / 15 cells / 16 cells
Outer Diameter	8", 10", 12", 16"
Filtration Area	0.36m ² (Φ8", 8cells) / 1.44m ² (Φ10", 16cells) 1.08m ² (Φ12", 9cells) / 1.44m ² (Φ12", 12cells) 1.8m ² (Φ12", 15cells) / 1.92m ² (Φ12", 16cells) 2.34m ² (Φ16", 9cells) / 3.12m ² (Φ16", 12cells) 3.9m ² (Φ16", 15cells) / 4.16m ² (Φ16", 16cells)

Material of Constructions

Media	Cellulose/Diatomaceous earth/ Resins etc.
Support/Diversion	Polypropylene
Seal Material	Silicone, EPDM, NBR, FKM

Performance

Max. Operating Temperature	80°C
Max. Operating DP	2Bar@25°C 1Bar@80°C

Features

- High flux filtration in pharmaceutical and food & beverage industries
- Thermal filtration fluid has no adverse influence to depth filter sheets
- Protection for subsequent sterile filters as well as chromatography columns
- Permeability and absorbability of filter sheets improving due to charged resins
- High dirt holding capacity combined with low protein adsorption
- Long service life and high economic efficiency
- Easy to operate, available in multiple grades and sizes

Applications

- Clarification of API liquids
- Filtration of vaccine production
- Blood plasma fractionation process
- Filtration of sugar syrups

Ordering Information



Removal Rating(μm)	End Cap Type	Outer Diameter	Seal Material	Cells
C001 = 0.1-0.3	D = DOE with flat gasket	8 = 8"	S = Silicone (red)	8 = 8 cells (8")
C002 = 0.2-0.4	S = SOE with double O-ring (only suitable for 8")	12 = 12"	E = EPDM (black)	9 = 9 cells (12",16")
C004 = 0.4-0.6		16 = 16"	B = NBR (black)	12 = 12 cells (12",16")
C006 = 0.6-1			F = FKM (black)	15 = 15 cells (12",16")
C100 = 1-3			N = No	16 = 16 cells (12",16")
C150 = 2-5				
C200 = 3-7				
C210 = 10-15				
C230 = 25-30				
C240 = 40-50				
C250 = 50-60				



Removal Rating(μm)	End Cap Type	Outer Diameter	Seal Material	Cells
C1001 = 0.04-0.20	D = DOE with flat gasket	8 = 8"	S = Silicone (red)	8 = 8 cells (8")
C1002 = 0.25-0.45	S = SOE with double O-ring (only suitable for 8")	12 = 12"	E = EPDM (black)	9 = 9 cells (12",16")
C1004 = 0.40-0.60		16 = 16"	B = NBR (black)	12 = 12 cells (12",16")
C1006 = 0.60-1.00			F = FKM (black)	15 = 15 cells (12",16")
C1008 = 0.80-1.00			N = No	16 = 16 cells (12",16")
C1100 = 1.00-2.25				
C1150 = 2.25-3.5				
C1200 = 3.5-5.0				
C1210 = 7-11				



Removal Rating(μm)	Outer Diameter	Seal Material	Cells
C001 = 0.1-0.3 C002 = 0.2-0.4	10 = 10"	S = Silicone (red)	16 = 16 cells
C004 = 0.4-0.6 C006 = 0.6-1	12 = 12"	E = EPDM (black)	
C100 = 1-3 C150 = 2-5		B = NBR (black)	
C200 = 3-7 C210 = 10-15		F = FKM (black)	
C230 = 25-30 C240 = 40-50			
C250 = 50-60			

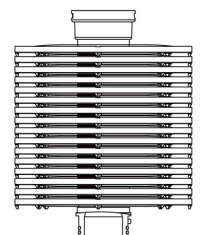

KKS Drawing

Removal Rating(μm)	End Cap Type	Outer Diameter	Seal Material	Cells
C001 = 0.1-0.3	TP = Top&Bottom support plastic part	12 = 12"	S = Silicone (red)	8 = 8 cells
C002 = 0.2-0.4	HD = Top handle	16 = 16"	E = EPDM (black)	9 = 9 cells
C004 = 0.4-0.6	HT = Top handle and Bottom support plastic part		B = NBR (black)	12 = 12 cells
C006 = 0.6-1			F = FKM (black)	15 = 15 cells
C100 = 1-3			N = No	16 = 16 cells
C150 = 2-5				
C200 = 3-7				
C210 = 10-15				
C230 = 25-30				
C240 = 40-50				
C250 = 50-60				

Removal Rating(μm)	End Cap Type	Outer Diameter	Seal Material	Cells
C1001 = 0.04-0.20	TP = Top&Bottom support plastic part	12 = 12"	S = Silicone (red)	8 = 8 cells
C1002 = 0.25-0.45	HD = Top handle	16 = 16"	E = EPDM (black)	9 = 9 cells
C1004 = 0.40-0.60	HT = Top handle and Bottom support plastic part		B = NBR (black)	12 = 12 cells
C1006 = 0.60-1.00			F = FKM (black)	15 = 15 cells
C1008 = 0.80-1.00			N = No	16 = 16 cells
C1100 = 1.00-2.25				
C1150 = 2.25-3.5				
C1200 = 3.5-5.0				
C1210 = 7-11				

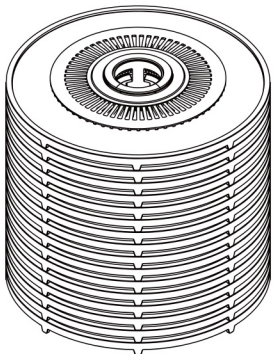

TP

Top&Bottom support plastic part

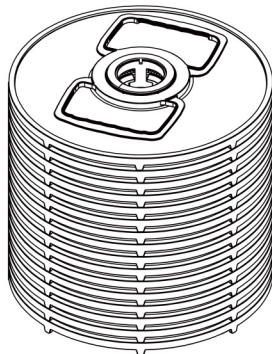

HD

Top handle

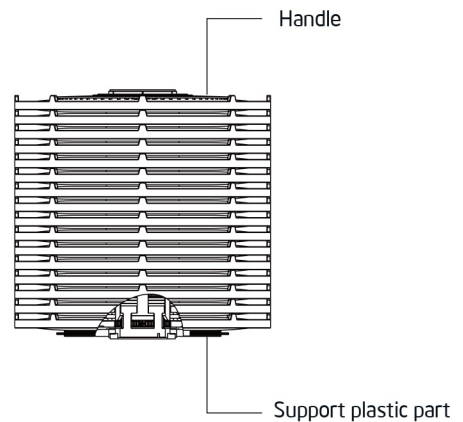

HT

Top handle and Bottom support plastic part

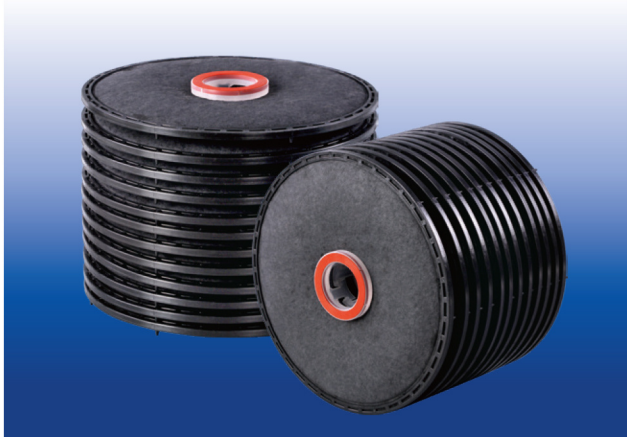

Great Wall CDS series Depth-stack Activated Carbon Filter Cartridges are developed to satisfy adsorption applications in food and beverage industry. By adding activated carbon, it increases the absorbability of depth filter sheets. CDS alleviate the concerns of possible carbon particle shedding downstream and solve the problems such as cleaning of process equipment and carbon removal from the process.

Features

- Color and flavor correction in pharmaceutical and food & beverage industries
- Thermal filtration fluid has no adverse affect to depth filter sheets
- Safe and reliable to use, no carbon dust shedding
- Absorbability of filter sheets greatly improving due to active carbon and charged resins
- Low solid waste disposal cost and high economic efficiency
- High flux and dirt holding capacity, long service life
- Easy to operate, available in multiple sizes to choose

Applications

- Decarburization filtration of Large Volume Parenteral (LVP)
- Dechlorination of water
- Decolorization of sweetener and sugar syrups
- Correction of color, flavor and odors in distilled spirits
- Color correction in juice and beer applications
- Gelatin Decolorization and deodorization

Dimension

Cells	8 cells / 9 cells / 12 cells / 15 cells / 16 cells
Outer Diameter	8",12",16"
Filtration Area	0.36m ² (Φ8", 8cells) 1.08m ² (Φ12", 9cells) / 1.44m ² (Φ12", 12cells) 1.8m ² (Φ12", 15cells) / 1.92m ² (Φ12", 16cells) 2.34m ² (Φ16", 9cells) / 3.12m ² (Φ16", 12cells) 3.9m ² (Φ16", 15cells) / 4.16m ² (Φ16", 16cells)

Material of Constructions

Media	Cellulose/Diatomaceous earth/ Resins/Activated carbon etc
Support/Diversion	Polypropylene
Seal Material	Silicone, EPDM, NBR, FKM

Performance

Max. Operating Temperature	80°C
Max. Operating DP	2Bar@25°C 1Bar@80°C

Guarantees

- Manufactured in a clean room environment
- Manufactured according to ISO9001:2015 certified quality
- Manufactured according to environmental management system ISO 14001:2015
- All components materials meet the requirements of the EU framework regulation [1935/2004/EC] regrading materials and articles intended to contact food.
- All components materials meet the FDA Indirect Food Additive requirements cited in 21 CFR 177-182.

Ordering Information

CDS	C2001	D	8	S	8
Removal Rating	End Cap Type	Outer Diameter	Seal Material	Cells	
C2001 = 5µm	D = DOE with flat gasket	8 = 8"	S = Silicone (red)	8 = 8 cells (8")	
	S = SOE with double O-ring (only suitable for 8")	12 = 12"	E = EPDM (black)	9 = 9 cells (12",16")	
		16 = 16"	B = NBR (black)	12 = 12 cells (12",16")	
			F = FKM (black)	15 = 15 cells (12",16")	
			N = No	16 = 16 cells (12",16")	

CDSH	C2001	TP	12	S	9
Removal Rating	End Cap Type	Outer Diameter	Seal Material	Cells	
C2001 = 5µm	TP = Top&Bottom support plastic part	12 = 12"	S = Silicone (red)	9 = 9cells	
	HD = Top handle	16 = 16"	E = EPDM (black)	12 = 12cells	
	HT = Top handle and Bottom support plastic part		B = NBR (black)	15 = 15cells	
			F = FKM (black)	16 = 16cells	
			N = No		

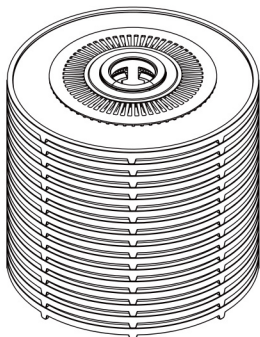

TP

Top&Bottom support plastic part

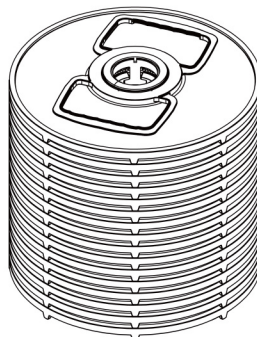

HD

Top handle

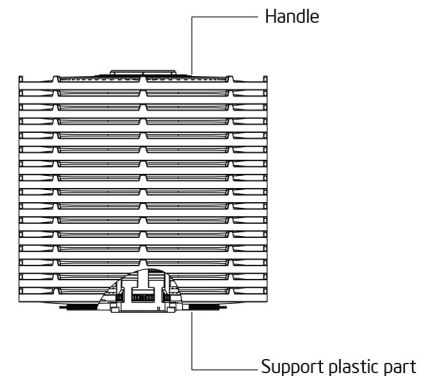

HT

Top handle and Bottom support plastic part



Depth-Stack Sanitary Filter Housings are a new type of depth-stack filter housing. Designed to meet requirements for sanitary construction with smooth crevice-free welding and TC-type sanitary connections. Easy to clean and disassemble. The co-linear inlet and outlet flow paths beneath the vessel shell serve to minimize liquid turbulence. Available for 8", 12" and 16" diameter cartridges up to four high modules to meet high flow rates requirements.

Features

- Ultra-high degree of polishing: Internal: $Ra \leq 0.3 \mu m$
External: $Ra \leq 0.4 \mu m$
- Liquid turbulence is minimized with co-linear inlet-outlet porting beneath the housing shell.
- Specially designed drain valves can optionally be installed on the inlet and outlet ports for easy liquid drainage.
- Allows vertical stacking of up to four depth-stack cartridges and provides high flow rates at high retention efficiency.
- Segmented cartridge design makes it more convenient to replace depth-stack cartridges and helps to reduce liquid loss.

Surface Finish

Finish Process Options:	Passivated, Electropolished, Mech. Polished
Polish Quality:	Internal: $Ra \leq 0.3 \mu m$ External: $Ra \leq 0.4 \mu m$

Materials

Shell Options:	304 or 316L Stainless Steel
Vent Valve:	304 or 316L
Eyebolts:	304
Legs:	304
Seal Materials:	Silicone, FKM, EPDM

Operating Conditions

Design Pressure:	0.6MPa (90psi)
Max. Operating Temperature:	150°C (302°F)

Connection

Shell Connection:	Eyebolt
Inlet & Outlet:	Tri-clamp or Flange
Vent Valve/Drain Valve:	Inner bore 4mm Connects with 8mm pipe
Pressure Gauge:	1.5" TC

Applications

- Pharmaceuticals: filtration of injectables, LVPs, water for injection, and other biological products
- Food and beverage: filtration of beer, wine, and distilled spirits, juices, syrups, and edible oils
- Chemical industry: filtration of grease and dirt, sludge, and gelatinous materials

Cartridge Sealing System

A spring-loaded sealing system provides optimal sealing compression to help prevent filter bypass even under the most arduous process conditions.



Dimensions (mm)

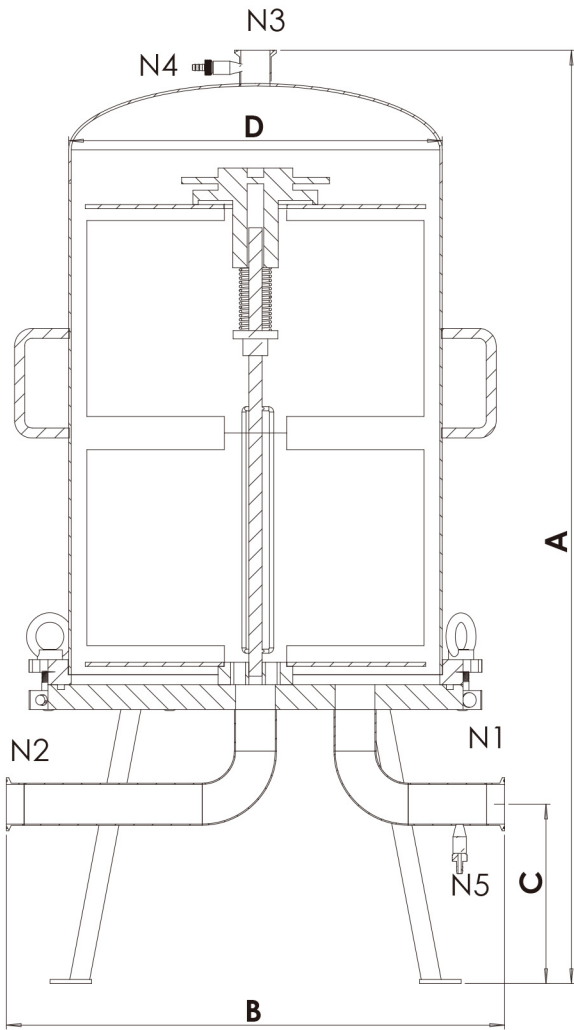

OD	No. of Cells	No. of Modules	A	B	C	D
8"	8	1	590	350	150	Φ250
	2*8	2	730			
	3*8	3	870			
	4*8	4	1,010			
12"	9	1	729	500	220	Φ350
	12	1	773			
	15/16	1	846			
	2*12	2	989			
	2*16	2	1,126			
	3*12	3	1,205			
	3*16	3	1,406			
16"	9	1	786	550	270	Φ350
	12	1	835			
	15/16	1	899			
	2*12	2	1,051			
	2*16	2	1,179			
	3*16	3	1,459			
	4*16	4	1,739			

Ordering Information

eg: HFJ120116T25SEM

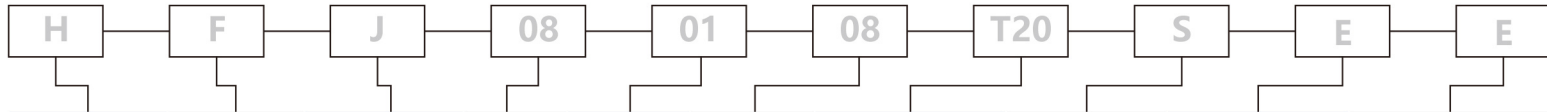

Series	Connection	Shell Material	OD	Quantity	Cells	Inlet & Outlet	Seal Material	Surface Finish (internal)	Surface Finish (external)
H = Depth-Stack Sanitary Filter Housing	F = DOE	J = 304	08 = 8"	01 = 1	08 = 8	T20=TC 3/4"	S=Silicone	E=Electropolished	E=Electropolished
		K = 316L	12 = 12"	02 = 2	09 = 9	T25=TC 1"	E=EPDM	M=Mech. Polished	M=Mech. Polished
			16 = 16"	03 = 3	12 = 12	T32=TC 1.25"	V=FKM	P=Passivated	
				04 = 4	15 = 15	T40=TC 1.5"			
					16 = 16	T50=TC 2"			
						F20=Flange DN20			
						F25=Flange DN25			
						F32=Flange DN32			
						F40=Flange DN40			
						F50=Flange DN50			
						...			



| Dedicated & Experienced in Filtration Industry

Shenyang Great Wall Filtration Co.,Ltd

☎ Mobile: +86-15566231251

✉ Email: clairewang@sygreatwall.com

🌐 Web: www.filtersheets.com

📍 Add: No.45 Yalujiang North Street, Huanggu District, Shenyang City, Liaoning Province, China

📮 P.C.: 110033